

Operating Manual for the Kangaroo® **224 Feeding Pump**

General Information

The Sherwood Medical Kangaroo® Feeding Pump is a rotary peristaltic pump designed to regulate the flow rate of enteral feedings. Among the features provided by this pump are:

- Portable operation-built in battery
- Wide flow rate range
 - 50-300 ml/hr in 5 ml/hr increments
- Small and lightweight for easy transport
- Touch panel operation
- Shut off and activation of audible and visible alarms when:
 - feeding container is empty
 - feeding tube becomes occluded
 - drop sensors blocked
 - battery low (alarms 15 minutes before pump shut off)
 - unit is left on "HOLD" longer than 2 1/2 minutes
 - pump set is improperly loaded
 - self diagnosed problem which requires technical servicing
 - pump motor malfunction
- Automatic systems check after pump has been turned ON
- Large LED display
- Removable power cord
- Low occlusion pressure. Pump will not overcome back pressure greater than approximately 12psi (82.7kPa)
- Integral pole clamp
- Use of safety interlock pump sets to prevent free flow from inadvertent misload of pump set onto pump
- Pump running indicator lights
- DC motor with intermittent operation
- Adjustable alarm volume
- Memory of flow rate, dose, and volume delivered settings for 24 hours after pump shut off

WARNING: This Kangaroo® Pump requires the use of a Kangaroo Pump Set. The pump will not operate if anything other than Kangaroo Pump Sets are loaded onto the pump.

1. Handle
2. Upper Drip Chamber Guide
3. Tubing Guide
4. Lower Drip Chamber Guide
5. Retainer Lock
6. Rotor Assembly
7. Touch Panel
8. LED Display and Pump Running Indicator Lights
9. Directions for Use Label
10. Power Cord
11. Rate Control Knob
12. Pole Clamp
13. Pole Clamp Knob
14. AC Light
15. Tubing Guide Latch

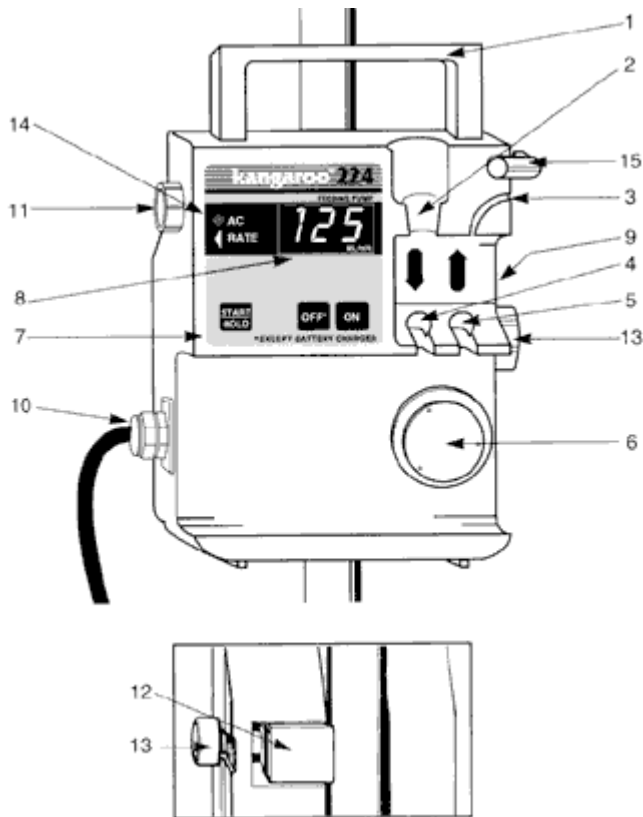

[Back to Table of Contents](#)

Operating Procedures

AC Light On whenever pump is plugged in.

Rate Control Knob Increases or decreases flow rate desired.

ON Powers the pump.

OFF Shuts pump off.

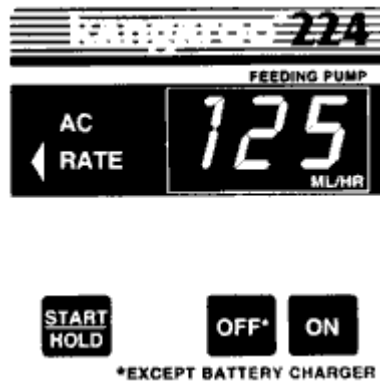

START/HOLD Starts pump rotor to deliver feeding formula and alternately puts unit on HOLD.

HOLD is used to stop fluid flow to:

1. Correct alarm condition (alarm is silenced)
2. Change the flow rate
3. Change pump set

NOTE: IF THE PUMP HAS BEEN PLACED ON HOLD AND NOT RESTARTED WITHIN 2.5

MINUTES, AN ALARM WILL SOUND.

NOTE: BATTERY WILL CHARGE WITH PUMP PLUGGED INTO WALL OUTLET, EVEN WHEN OFF BUTTON HAS BEEN PRESSED.

Normal Operations Insert hospital grade plug into AC wall outlet.

Battery Operation Unplugging the pump from the AC line outlet will automatically put the pump on battery power. A new battery, when fully charged, will operate the instrument for more than 24 hours at 125 milliliters per hour. Approximately 15 minutes prior to battery discharge, a low battery alarm will occur, (see [alarm](#) section). When complete discharge occurs, the pump will automatically turn itself off.

NOTE: AS THE BATTERIES GET OLDER, THE TIME FROM LOW BATTERY ALARM TO COMPLETE DISCHARGE MAY BE LESS THAN 15 MINUTES.

The battery will charge continuously during AC line operation.

To recharge battery, insert hospital grade plug into AC wall outlet. Battery will automatically begin charging. The recharge time for a fully discharged battery is approximately 15 hours.

The battery will charge whenever the pump is plugged into a wall outlet, even when the OFF button has been pressed. To be certain that power to all circuits has been disconnected, the power cord must be unplugged from the wall outlet.

Beginning Administration Below are general instructions for inserting all Sherwood Medical Pump Sets into the Kangaroo® 224 Feeding Pump.

1. Press ON.
2. Wait while pump performs system check.
3. When flow rate is displayed, set desired rate in ml/hr by turning rate control knob on side of pump.

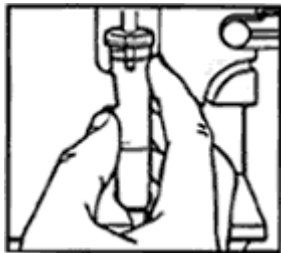

4. Slide drip chamber into upper drip chamber guide.

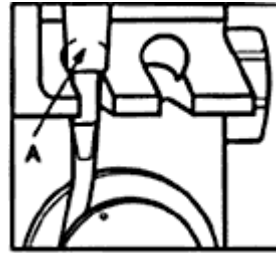

5. Seat and secure chamber in lower drip chamber guide. (A).

6. Remove distal connector protective cover.
7. Slowly open clamp and fill entire line with fluid, leaving a few drops of fluid in the drip chamber.

NOTE: AVOID FILLING THE DRIP CHAMBER MORE THAN HALF FULL.

8. Close clamp
9. Attach distal connector to feeding tube.

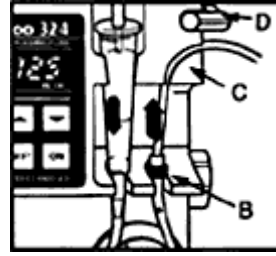
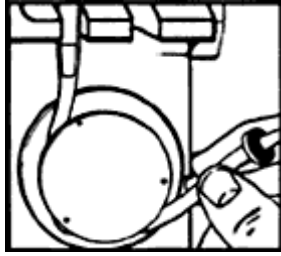

10. Grasp silicone tubing and gently stretch around rollers. Insert retainer into retainer lock (B). Thread tubing over tubing guide (C). Secure latch over tubing (D).

- **VERIFY THAT THE PUMP SET IS PROPERLY LOADED IN THE PUMP BEFORE PROCEEDING. AN IMPROPERLY LOADED PUMP SET COULD RESULT IN UNCONTROLLED FLOW AND POSSIBLE PATIENT INJURY.**

11. Open control clamp.
12. Press START/HOLD.
13. Proceed with feeding.

Example of proper placement of Pump Set in Kangaroo 224 Pump.

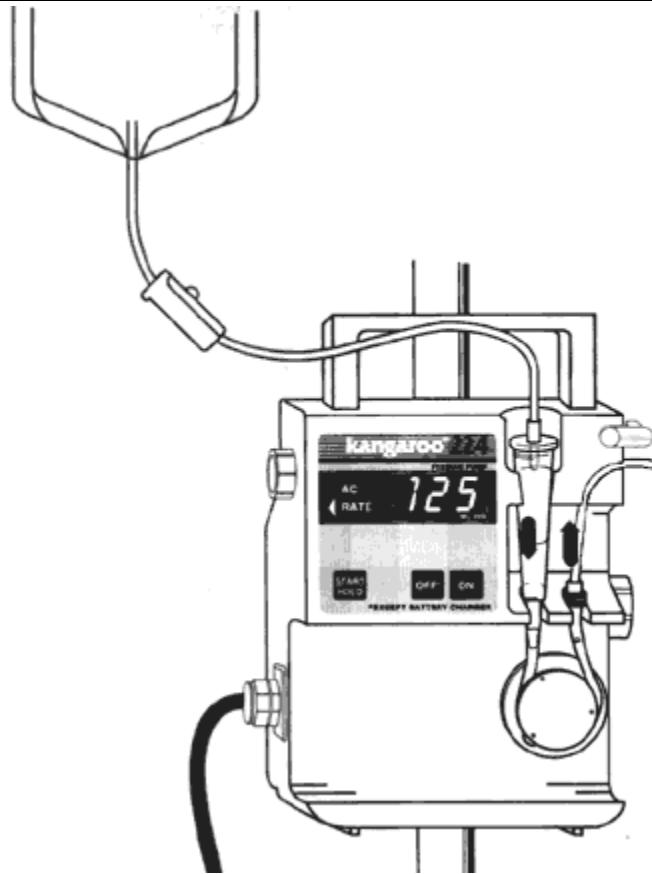

[Back to Table of Contents](#)

Alarms

The Sherwood Medical Kangaroo® 224 Feeding Pump has been designed to provide audible and visible alarms under several conditions where proper performance cannot be maintained. When an alarm occurs, press the START/HOLD button on the pump and perform the necessary procedures to correct the alarm condition.

NOTE: THE VISIBLE ALARM IS IN THE FORM OF A MESSAGE SHOWN ON THE DISPLAY.

Visible Alarm Definitions

No Set (no SEt)

The feeding set is not installed or is installed improperly. See [Operating Procedures](#) for installation instructions.

Flow Error (FLO Err)

- The feeding container is empty. To correct this situation, if more feeding is required, refill the container with the desired amount of formula and follow the steps in the [Operating Procedures](#) of this manual.
- The feeding container, the feeding set tubing, or the feeding tube itself has become occluded beyond the pump's capability to pump. Alarm will activate at approximately 12 psi (8~.7 kPa). To correct this condition, determine where in the system the occlusion has occurred. Correct occlusion condition. Press START/HOLD switch. Continue with feeding.
- The drop sensors are blocked and will not be able to detect drops as they come through the drip chamber. To correct this condition, check drop sensors on inside of upper drip chamber guide and clean off any material that may be blocking sensors.

Low Battery (Lo bAt)

- This alarm is activated when the battery begins to run down and flow rate accuracy can no longer be maintained. The low battery alarm occurs approximately 15 minutes before complete discharge. When complete discharge occurs, the pump automatically turns itself off.
- To correct this condition, plug the pump into an AC wall outlet. When the pump is connected to a wall outlet, it will continue to operate and charge the battery at the same time. Once the low battery alarm has sounded, it will take approximately 15 hours to fully recharge.

Hold Error (Hid Err)

If the pump is left in the hold mode for approximately 2 1/2 minutes "HOLD ERROR" will alarm.

System Error (Sys Err)

- Rotor is not turning while pump is in start mode.

NOTE: DOTS WILL FLASH ACROSS TOP OF LED DISPLAY WHILE PUMP IS RUNNING.

- Rotor is turning, but is not detected by rotor sensors. Do not try to repair pump. Return pump for technical service.

NOTE: FOR ALL ALARM CONDITIONS, PRESSING THE START/HOLD BUTTON WILL SILENCE THE AUDIBLE ALARM. THE VISIBLE DISPLAY WILL CONTINUE TO FLASH UNTIL THE START/HOLD BUTTON IS PRESSED AGAIN.

[Back to Table of Contents](#)

Cleaning

Important User Information

CAUTION: DO NOT IMMERSE PUMP OR POWER CORD IN WATER OR OTHER CLEANING SOLUTION; CLEAN USING A DAMP (NOT WET) CLOTH OR SPONGE. FAILURE TO FOLLOW THE CLEANING PROCEDURES DESCRIBED HEREIN COULD RESULT IN HAZARDS TO USERS. As with any electrical device, care must be taken to prevent liquid from entering the pump or the power cord receptacle to avoid electrical shock hazard, fire hazard, or damage to electrical components.

Should any of the following events occur, DO NOT USE the pump until it has been properly cleaned and serviced by personnel trained in servicing Kangaroo® pumps:

- wetting of the pump's power cord or leakage into the pump interior during cleaning.
- spillage of large amounts of formula onto the pump exterior or any spillage on the power cord.

General Cleaning Directions

Cleaning of Kangaroo® 224 pumps must be performed as follows:

CAUTION: Disconnect pump from AC power source before cleaning. Upon completion of cleaning, do not connect to AC power source until pump and power cord are thoroughly dry.

- A mild detergent should be used for general cleaning. If necessary, the pump may be cleaned with a 10:1 water and hypochlorite mixture, however, repeated cleaning with this solution can damage the plastic pump case. Isopropyl alcohol applied with a damp (not wet) cotton swab may be used for cleaning difficult-to-reach areas, such as the drop sensor and inside the AC receptacle, however, it should be used sparingly because repeat cleaning may damage the case.
- DO NOT USE strong cleaners such as Spray-Nine, PhisoHex, Hibiclens, or Vesta-Syde because damage to the pump case housing can result.

Directions For Cleaning Pump Housing

- Refer to General Cleaning Directions before starting.
- Clean outside surface with a damp (not wet) cloth or sponge and keep pump in upright position as much as possible.
- Avoid excess moisture near handle hinges.
- Avoid excess moisture near pole clamp area.
- When cleaning around buzzer opening on back of pump housing, do not let cleaning solution get inside pump.

Directions For Cleaning Pump Power Cord

- Refer to General Cleaning Directions before starting.
- Unless soiling is observed, the power cord should not be cleaned.

- If cleaning of the power cord is necessary, wipe the exterior surfaces of the wall plug of the power cord with a cloth dampened with isopropyl alcohol.

CAUTION: Avoid exposing power cord to excess moisture, as this can lead to an electrical shock or fire hazard.

Directions For Cleaning Drop Detector

- Refer to General Cleaning Directions before starting.
- Clean the drop sensors in the upper drip chamber guide with a cotton swab dampened with isopropyl alcohol.
- Be sure sensor areas are clear.

Directions For Cleaning Rotor Assembly

- Refer to General Cleaning Directions before starting.
- Loosen rotor set screw with a 0/64" allen wrench and gently pull rotor forward off shaft. After removing rotor, avoid getting any moisture in the rotor shaft opening.
- Clean rollers thoroughly with warm soapy water, or isopropyl alcohol if necessary.
- Be sure all parts of rotor are completely dry before putting it back onto shaft.
- To replace rotor, align set screw on hub of rotor with the flattened section of the output shaft.
Push rotor into place and tighten set screw (Do not over tighten).

Preventive Maintenance

This pump must be periodically serviced to assure proper functioning and safety. The recommended service interval is 6 months, but in no case less than once each twelve (12) months per JCAHO. Servicing must be performed by personnel trained in servicing Kangaroo® pumps and may be done at the user's SPARROW REGIONAL MEDICAL SUPPLY biomedical engineering department, an outside service, or by Sherwood Factory Service. To arrange for Sherwood Factory Service, call 1-800-448-0190.

[Back to Table of Contents](#)

Troubleshooting Guide		
Listed below are some of the probable causes of alarm conditions and their corrections.		
Symptom	Probable Cause	Corrections
Flow Error Alarm (FLO Err)	Feeding Container is empty. Feeding tube or feeding set tubing occluded.	Refill feeding container. If bag has been in use for 24 hours, replace Locate point of occlusion and correct. Note: occlusion may occur upstream from pump. • Feeding Container

	<p>Drip chamber is improperly placed in pump.</p> <p>Drip chamber walls are coated with feeding formula.</p> <p>Sensors in upper drip chamber guide are blocked.</p>	<ul style="list-style-type: none"> • Feeding Pump Set (control clamp closed) • Feeding Tube-patency of feeding tube should be checked <p>Check to make sure drip chamber is properly "locked" in position is drip chamber.</p> <p>Check to make sure formula is not preventing detectors from proper operation. If formula cannot be removed from inside walls of chamber via chamber manipulation, replace set.</p> <p>Check to make sure formula is not preventing detectors from proper operation. If formula cannot be removed from inside walls of chamber via chamber manipulation, replace set.</p>
<p>Low Battery Alarm (Lo bAt)</p>	<p>Battery has been run down below point of maintaining accuracy of pump.</p>	<p>Plug pump power cord into outlet.</p>
<p>No Set (no SEt)</p>	<p>Pump set has been improperly placed into pump.</p>	<p>Check to make sure only Kangaroo® Pump Pet has been placed onto the pump. Check to make sure that retainer clip on pump set has been properly positioned into retainer lock on pump.</p>
<p>System Error (SYs Err)</p>	<p>Rotor is not turning while pump is running.</p> <p>Rotor is turning but is not detected by rotor sensors.</p>	<p>Return pump for technical service.</p>
<p>Back to Table of Contents</p>		

Factory Service

If the pump malfunctions, please contact Sparrow Regional Medical Supply at 517.364.2115. The pump can be repaired on site or sent back to Sherwood Medical.

[Back to Table of Contents](#)

Specifications

Type Infusion Device Volumetric

Pumping Mechanism Rotary Peristaltic

Pump Set Required Sherwood Medical Kangaroo® Feeding Pump Administration Sets

Operating Range

5-300 ml/hr increments

Memory of Settings When Pump is Off 24 hours for all settings

Accuracy ±10% of selected flow rate

Occlusion Pressure 12 psi (82.7 kPa) Nominal

Alarms

- Flow Error
- Low Battery
- Hold Error
- No Set
- System Error

Battery

- Rechargeable
- Automatically charges when pump is plugged into wall outlet. Recharge time for fully discharged battery is approximately 15 hours.
- A new battery, when fully charged, will operate for approximately 24 hours at 125 milliliters per hour.

Dimensions Approximately 7.25" High x 5.5" Wide x 4.25" Deep

Weight Approximately 3.625 lbs.

Case Material ABS Plastic -FIRE RESISTANT

Power Requirements 120V, 60 Hz, 1 Amp

[Back to Table of Contents](#)

Warranty

Sherwood Medical Company (hereinafter referred to as Sherwood) warrants that each Kangaroo® Enteral Feeding Pump will be free from defects in materials and workmanship under normal use and service for a period of sixty (60) days from the date of delivery by Sherwood to the first purchaser. If any such defect occurs during the warranty period, the aforesaid purchaser should communicate directly with Sherwood. If returned to Sherwood, Sherwood will arrange for repairs or replacement within the terms of the warranty. The defective pump should be promptly returned, properly packaged, postage prepaid. Loss or damage in return shipment to Sherwood shall be at Purchaser's risk.

In no event shall Sherwood be liable for any incidental, indirect or consequential damages in connection with the purchase or use of the pump. This warranty shall not apply to, and Sherwood shall not be responsible for, any loss arising in connection with the purchase or use of such pump which has been repaired by anyone other than an authorized Sherwood representative or altered in any way as, in Sherwood's judgement, to affect its stability or reliability or which has been subject to misuse, negligence or accident, or which has or had been used otherwise than in accordance with the instructions furnished by Sherwood. Sherwood neither assumes nor authorizes any representative or other person to assume for it any other liability in connection with the sale of such pumps.

SHERWOOD DISCLAIMS ALL OTHER WARRANTIES, EXPRESS OR IMPLIED, INCLUDING ANY IMPLIED WARRANTY OF MERCHANTABILITY OR OF FITNESS FOR A PARTICULAR PURPOSE OF APPLICATION OTHER THAN THOSE EXPRESSLY SET FORTH IN THE APPROPRIATE PRODUCT LABELING OR USER INFORMATION MANUAL. IN NO EVENT WILL SHERWOOD BE LIABLE FOR ANY INCIDENTAL, INDIRECT OR CONSEQUENTIAL DAMAGES IN CONNECTION WITH THE PURCHASE OR USE OF ITS PRODUCTS.



Kangaroo is a registered trademark of Sherwood Medical and is used with permission.

[Back to Table of Contents](#)

[Back to Services and Equipment care](#)

Last modified on: 04/04/2002 11:20:24 AM